

BENCH WOODLINE

CONCRETE STREET FURNITURE





PARC INDUSTRIEL DE TOURNAI OUEST 2

16, RUE DES SABLIERES

7503 TOURNAI (BELGIUM)

T +32 (0)69 67 26 26 | F +32 (0)69 67 26 27

info@urbastyle.com | www.urbastyle.com | Follow us: 

CONTENTS

01. SMALL ELEMENTS AND DIMENSIONS	4
02. LARGE ELEMENTS AND DIMENSIONS	6
03. COMBINE AND CREATE	7
04. ACCESSORIES	8
05. ACCESSIBILITY AND HANDLING	8
06. COLORS AND FINISHINGS	9
07. DESIGN & PROJECTS	10

01. SMALL ELEMENTS AND DIMENSIONS

SMALL ELEMENTS - CHAMFERS AT TWO SIDES

These are elements with a trapezoidal shape and chamfers. You can combine the different elements to create an infinite number of combinations.

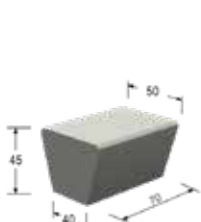

ZB.WL.01



ZB.WL.02



ZB.WL.03

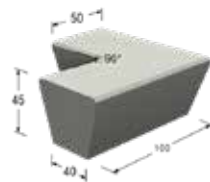

ZB.WL.04

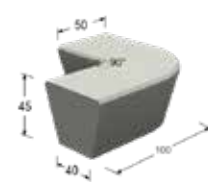

ZB.WL.05

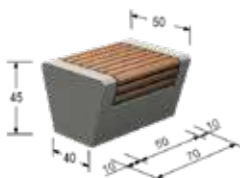

ZB.WL.06

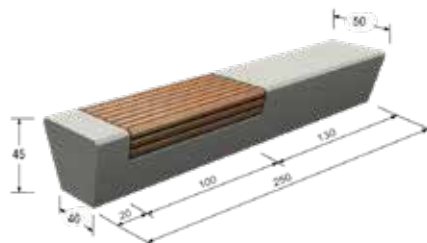

ZB.WL.07

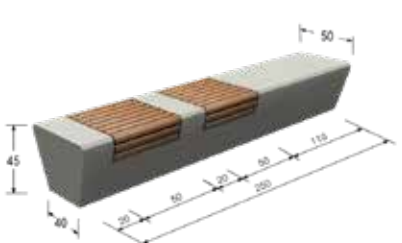

ZB.WL.08

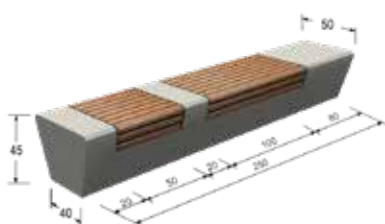

ZB.WL.09

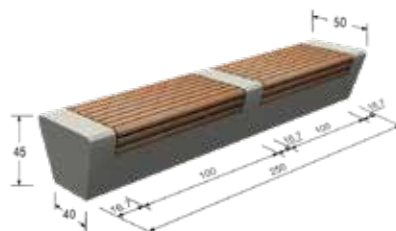

ZB.WL.10

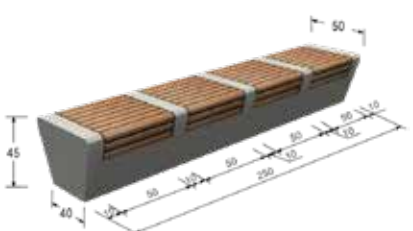

ZB.WL.11

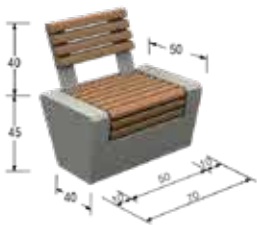

ZB.WL.12

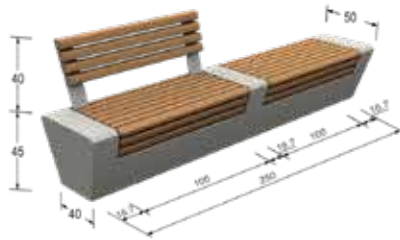

ZB.WL.13



ZB.WL.14

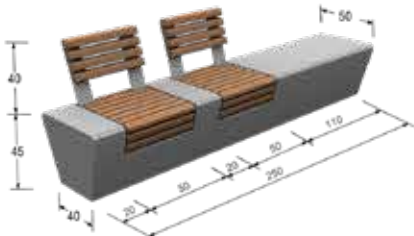

ZB.WL.15

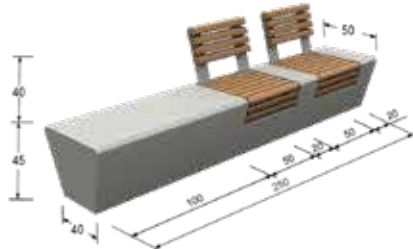

ZB.WL.16

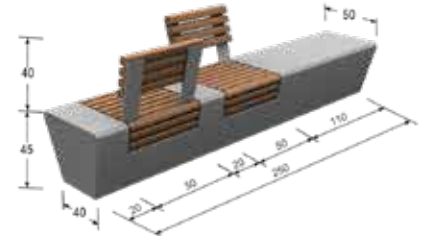

ZB.WL.17

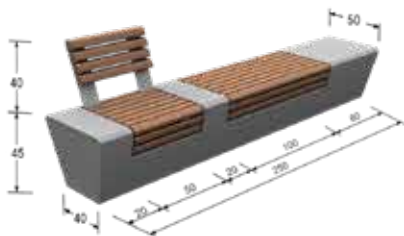

ZB.WL.18

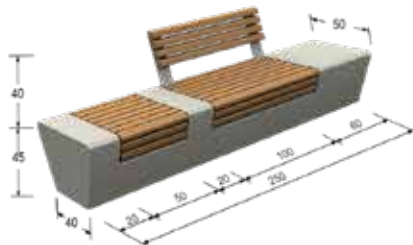

ZB.WL.19

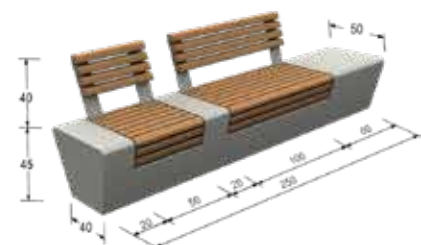

ZB.WL.20

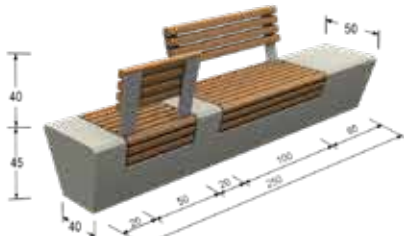

ZB.WL.21

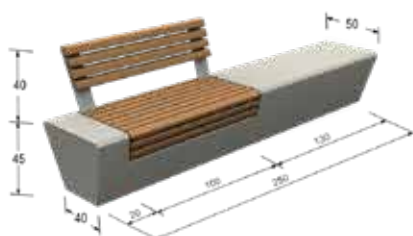

ZB.WL.22

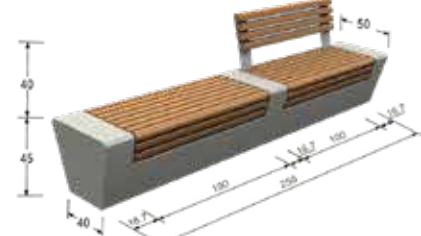

ZB.WL.23

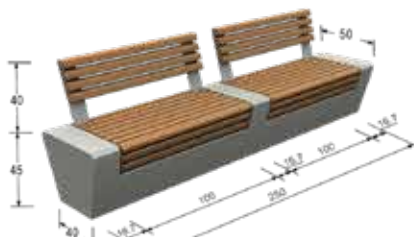

ZB.WL.24

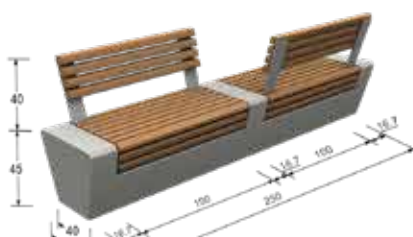

ZB.WL.25

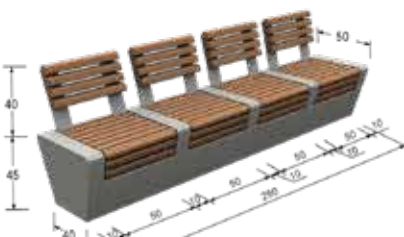

ZB.WL.26

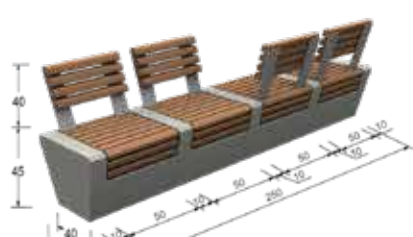

ZB.WL.27

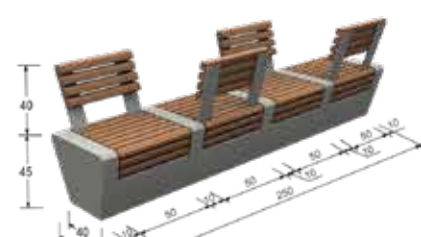

ZB.WL.28

02. LARGE ELEMENTS AND DIMENSIONS

LARGE ELEMENTS - CHAMFER AT ONE SIDE

These are elements with a trapezoidal shape and a chamfer. You can combine the different elements to create a variety of combinations.

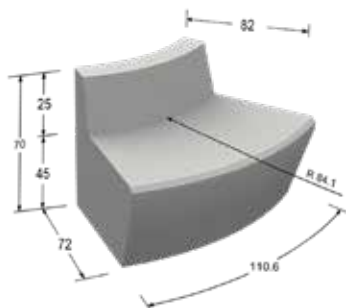

Z B . W L . 2 9

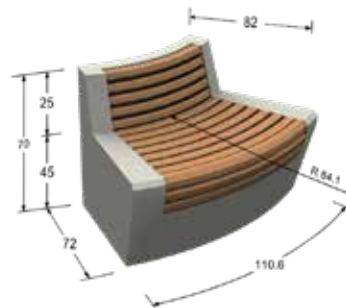

Z B . W L . 3 0

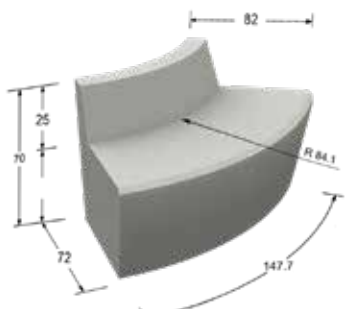

Z B . W L . 3 1

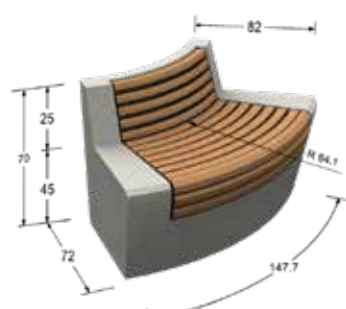

Z B . W L . 3 2

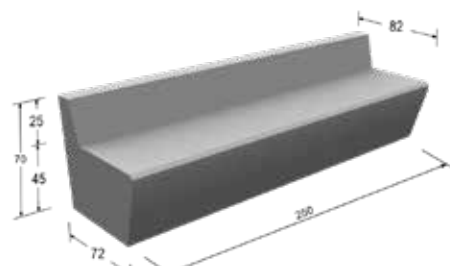

Z B . W L . 3 3

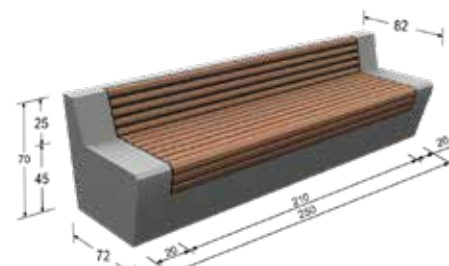

Z B . W L . 3 4

03. COMBINE AND CREATE

EXAMPLES OF COMBINATIONS WITH LARGE ELEMENTS - CHAMFER AT TWO SIDES

When you combine the different large elements you can create what you want.
Below you can find some ideas of benches, tree grate - benches, circular benches,

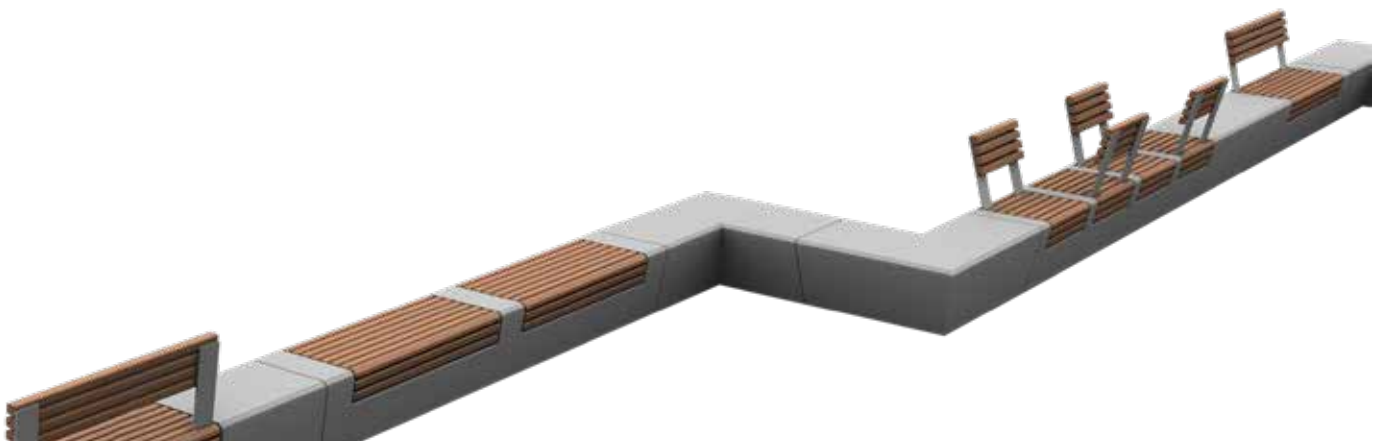
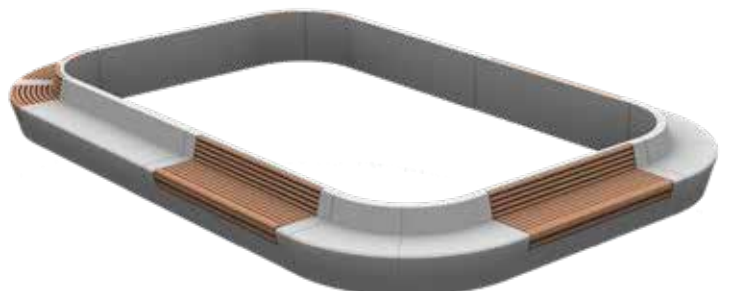
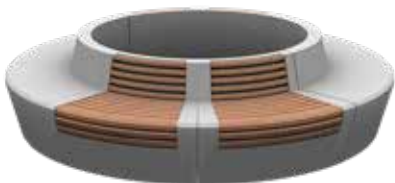
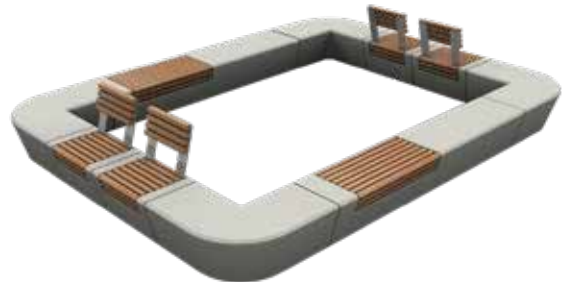
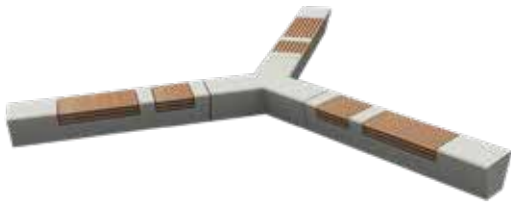
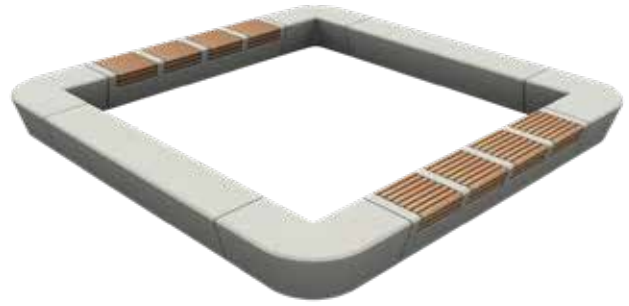
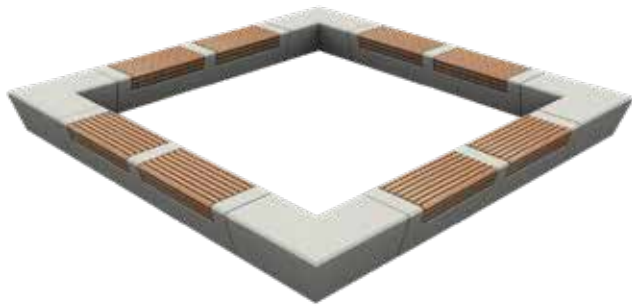

04. ACCESSORIES

You can add accessories to your bench. Finish your creation by using some wooden seats. You can also use armrests for elderly people or the anti-skates to prevent damages on the benches.



Z B . A C . 0 5



Z B . A C . 0 6

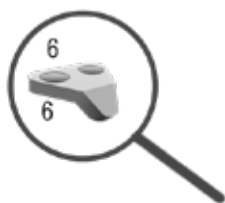

Z B . A C . 0 7

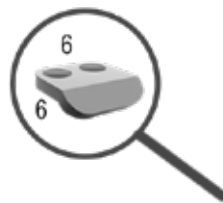

Z B . A C . 0 8

05. ACCESSIBILITY & HANDLING



Perimeter is easily noticeable with white cane.
Appropriate seat height with optional relaxing backrest. Easy to stand up thanks to back slope under seating.
Volume is easily understandable and friendly for people with cognitive disabilities.



The elements are always handled with care using a crane and straps during loading on the truck and during unloading on the building site.

06. COLOURS AND FINISHINGS

FERRO*

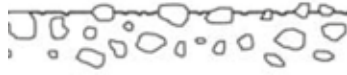

The cement skin at the surface of concrete is removed, allowing aggregates to appear. This finishing provides also a light roughness to the aggregates.

FINO*

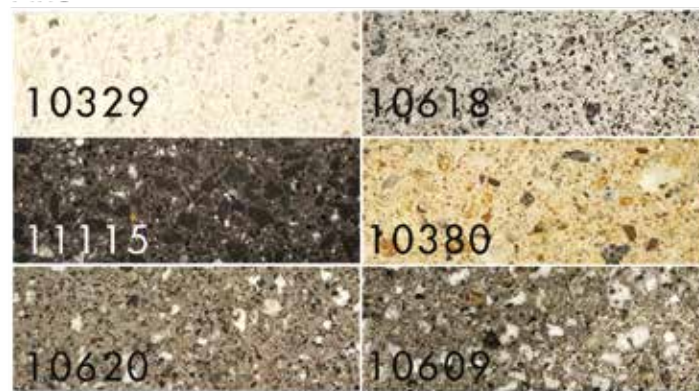

The cement skin of the hardened concrete surface is removed by polishing with thinner and thinner grains. This allows the aggregates to show-up.

FINERRO*

permeabile

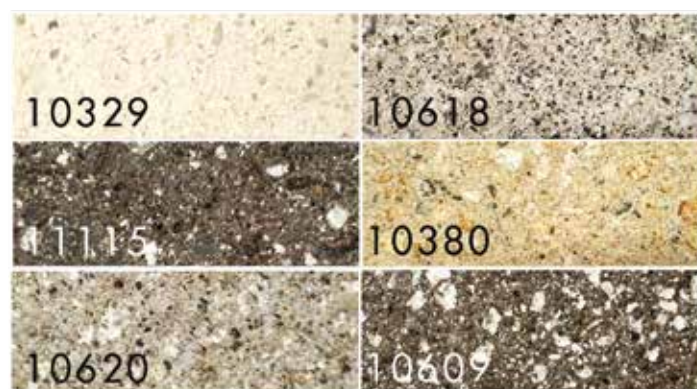

The cement skin of the concrete surface is removed in a special way allowing natural aggregates to appear and providing a satin aspect to the surface. It feels like velvet.

*Indicative sample | Subject to colour and structure variations

07 DESIGN & PROJECTS

The Woodline bench is a creation of the Urbastyle designers team. Our team is always thinking about the user's needs and experience. They create designs that are timeless and are also suitable for young and old.

The combination of white concrete and wood gives refreshing ideas. Our designers always aim to work together with the technicians and production team to create practical and architectural concepts that embellish public spaces.

The Woodline bench is made of different elements in you can group in two categories.

The small elements are freestanding elements that you can put in the middle of an empty place. You have different connection element to create complex combinations. The small element exist with or without wood and with or without backrests.

The large elements are freestanding elements. They are perfect to create complex freestanding benches.

They are perfect to create circular benches or treegrate benches. You can also accessorize your Woodline bench by an armrest or a anti-skate to prevent damages on the benches.





ENGLAND: UNIVERSITY OF BRISTOL - BUSINESS MANAGEMENT
Woodline benches and individual seats



BELGIUM: HALLE - NEDERHEM



PARC INDUSTRIEL DE TOURNAI OUEST 2

16, RUE DES SABLIERES

7503 TOURNAI (BELGIUM)

T +32 (0)69 67 26 26 | F +32 (0)69 67 26 27

info@urbastyle.com | www.urbastyle.com | Follow us:

IN COLLABORATION WITH:

